

# SPINAL IMPLANTS – Test Methods

## Internal fixators and plates

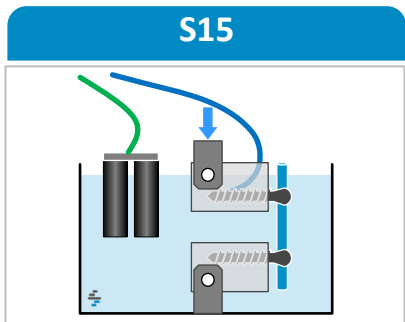

## Cages and vertebral body replacement implants

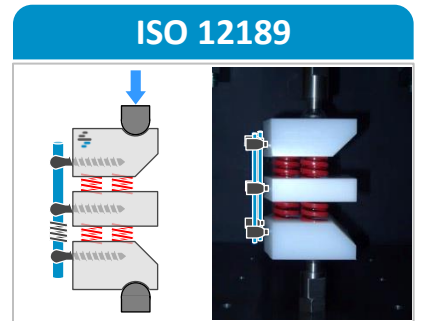
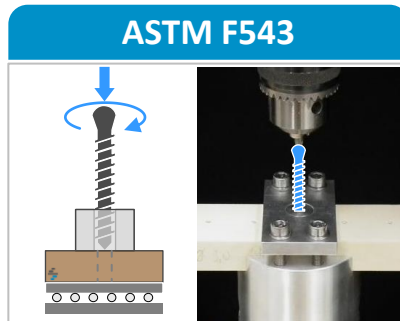
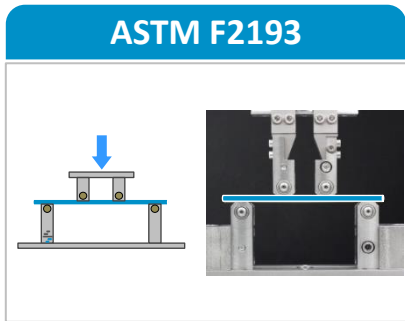
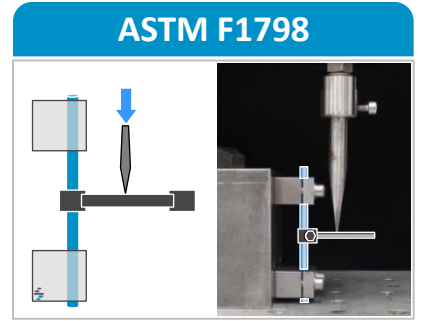
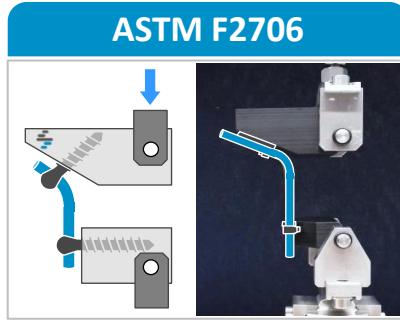
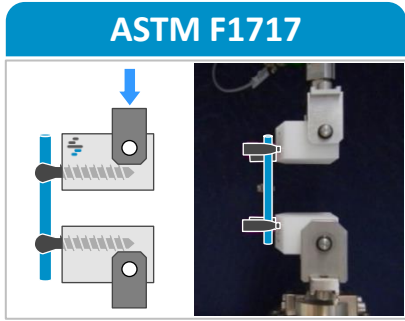
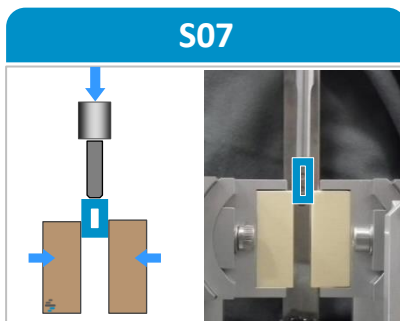
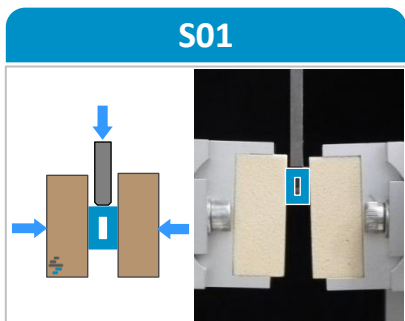
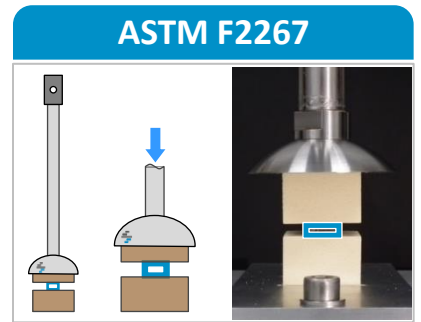

# SPINAL IMPLANTS – Test Methods

## Intervertebral disc prostheses

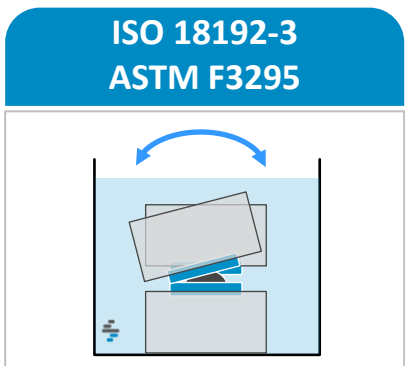
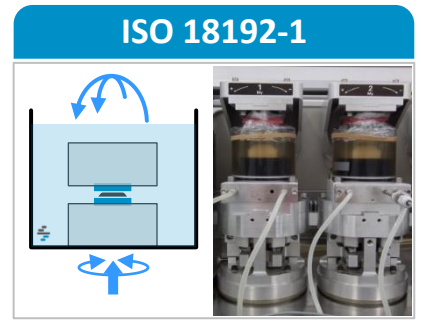
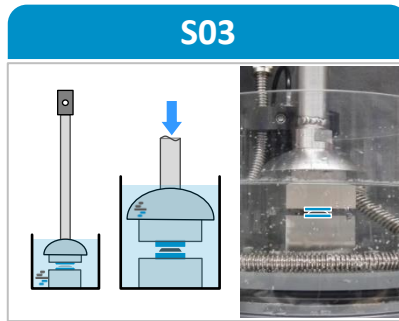
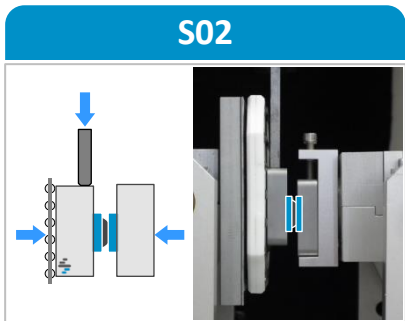
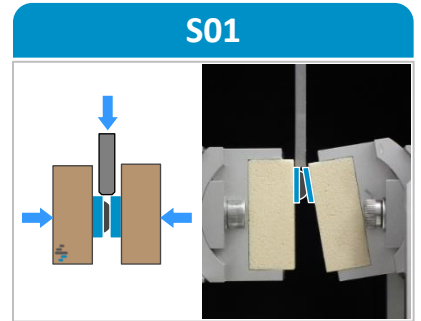
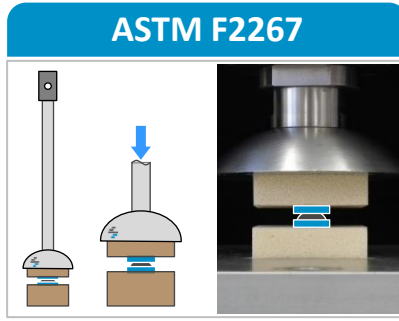
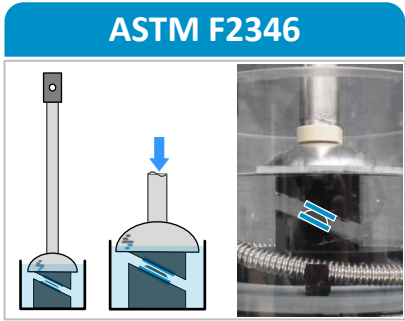

## Nucleus replacement implants

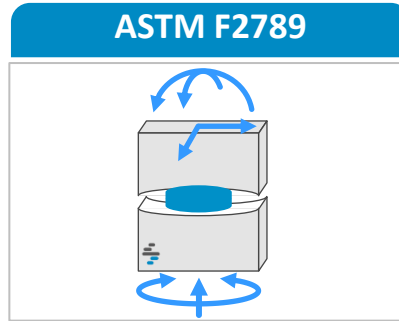
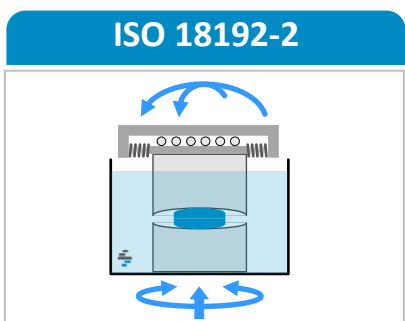

# SPINAL IMPLANTS – Test Methods

## Extradiscal motion preserving implants

ASTM F2624

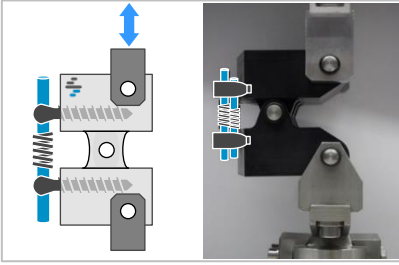

ISO 12189

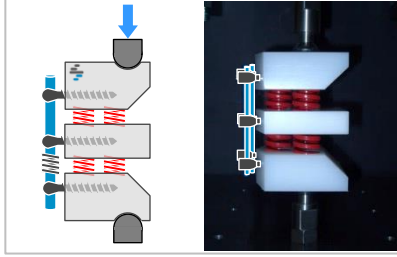

ASTM F2790

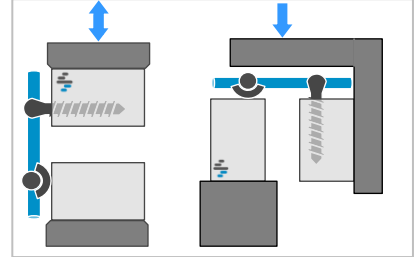

ASTM F2694

